



# Oxygas P-500 User Handbook



Certificate No Q/09780

**Issue 1**

**29/07/04**

**Part Number: 42645**

**GMI welcomes comments on all our publications. Your comments can be of great value in helping us to improve our customer publications. Please send any comments that you have to our Sales Department at GMI. Contact details are provided inside the back cover of this handbook.**

**Instrument Service / Repair contact details are also provided inside the back cover of this handbook.**

## **COPYRIGHT**

This User Handbook is copyright of Gas Measurement Instruments Ltd (GMI) and the information contained within, is for use only with the Oxygas P-500 instrument. Reproduction, in whole or in part, including utilisation in machines capable of reproduction or retrieval without written permission of Gas Measurement Instruments Ltd is prohibited. Reverse engineering is not permitted.

## **LIABILITY**

Every care has been taken in the preparation of this document, but GMI Ltd do not accept any responsibility for errors or omissions and their consequences. Information in this document is subject to change without notice. This document does not constitute a specification or basis for a contract. Your statutory rights under law are not affected.

## **MODIFICATION NOTICES**

GMI aim to notify customers of relevant changes in the product operation and maintain this manual up to date. In view of the policy of continuous product improvement there may be operational differences between the latest product and this manual.

This Handbook is an important part of the Oxygas P-500 product. Please note the following points:

- It should be kept with the instrument for the life of the product.
- Amendments should be attached.
- This Handbook should be passed on to any subsequent owner/user of the instrument.
- Although every care is taken in the preparation of this Handbook it does not constitute a specification for the instrument.



## **SOFTWARE**

Software supplied on EPROM or similar device for use in a particular product, may only be used in that product and may not be copied without the written permission of Gas Measurement Instruments Ltd. Reproduction or disassembly of such embodied programmes or algorithms is prohibited. Ownership of such software is not transferable and GMI Ltd does not warrant that the operation of the software will be error free or that the software will meet the customer's requirements.

## **DISPOSAL ADVICE**

When no longer in use, dispose of the instrument carefully and with respect for the environment. GMI will dispose of the instrument without charge if returned to the factory.

### SAFETY

- The instrument must be regularly serviced and calibrated by fully trained personnel in a safe area.
- **Batteries:** Alkaline batteries or \*Rechargeable battery pack must be exchanged (\*and recharged) in a safe area and fitted correctly before use. Never use damaged batteries or expose to extreme heat. See Section 4 : OPERATOR MAINTENANCE.
- Only GMI replacement parts should be used.
- If the instrument detects gas, follow your own organisation's procedures and operational guidelines.
- The combustion chamber is a flameproof assembly and must not be opened in the presence of a flammable atmosphere.
- Gas can be dangerous and care should always be taken in its use.
- Oxygas P-500 instruments are certified as EEx iad IIC T4 (-20°C ≤ Tamb ≤ 50°C). BAS01ATEX2292   II 2 G. UL Class 1 Groups A, B, C and D.
- This equipment is designed and manufactured to protect against other hazards as defined in paragraph 1.2.7 of Annex II of the ATEX Directive 94/9/EC

Any right of claim relating to product liability or consequential damage to any third party against GMI is removed if the warnings are not observed.

### AREAS OF USE

Exposure to certain chemicals can result in a loss of sensitivity of the flammable sensor. Where such environments are known or suspected it is recommended that more frequent response checks are carried out. The chemical compounds that can cause loss of sensitivity include Silicones, Lead, Halogens and Sulphur. Do not use instrument in potentially hazardous atmospheres containing greater than 21% Oxygen. The enclosure material is polypropylene and must not be exposed to environments which are liable to result in mechanical or thermal degradation or to damage caused by contact with aggressive substances. Additional protection may be required in environments where the instrument enclosure is liable to damage.

### STORAGE, HANDLING AND TRANSIT

The batteries in the rechargeable pack contain considerable energy and care should be taken in their handling and disposal. Battery packs should be removed if the instrument is stored for longer than 3 months. The instrument is designed to handle harsh environments. The sensing elements are sealed to IP54 and the rest of the instrument to IP64. If not subject to misuse or malicious damage, the instrument will provide many years of reliable service. The instrument contains electrochemical sensors with a life of 2 years. Under conditions of prolonged storage the sensors should be removed. The sensor contains potentially corrosive liquid and care should be taken when handling or disposing of the sensor, particularly when a leak is suspected.

---

## **REVISION RECORD**

<b>Date</b>	<b>Pages</b>	<b>Description Of Change</b>
Issue 1 29/07/04	All	New Handbook



---

# CONTENTS

COPYRIGHT .....	i
LIABILITY .....	i
MODIFICATION NOTICES .....	i
SOFTWARE .....	i
DISPOSAL ADVICE .....	i
SAFETY .....	ii
AREAS OF USE .....	ii
STORAGE, HANDLING AND TRANSIT .....	ii

---

REVISION RECORD .....	iii
-----------------------	-----

---

INTRODUCTION .....	1
Overview .....	2
Combustible Gas Indicator - Leak Detection .....	2
Purging .....	4

---

GENERAL INFORMATION .....	13
Ranges of Operation .....	13
LEL, 0 to 100% .....	13
Volume Gas, 0 to 100 % .....	14

Oxygen, 0 – 25% .....	14
PPM Flammable 0 – 1000 ppm .....	15
Construction .....	15
Batteries .....	16
Disposable Alkaline (LR20) Dry Cell Batteries .....	16
Rechargeable Battery Pack .....	16
Filters .....	17
Liquid Crystal Display (LCD) .....	17
Before Use Checks .....	17

---

<b>OPERATING INSTRUCTIONS .....</b>	<b>19</b>
Modes of Operation .....	19
Switching On .....	20
Calibration Date Features .....	21
Switching Off the Instrument Pump .....	21
Switching On in Purge Mode .....	22
Changing Range .....	22
Zeroing the PPM Range .....	23
Switching Off .....	23
Summary of Button Operation .....	24
Operator Messages / Fault Flags .....	24



---

<b>OPERATOR MAINTENANCE .....</b>	<b>27</b>
Rechargeable Battery Pack .....	27
Standard Charger .....	27
Flatbed Charger .....	28
Smart Charger .....	28
Replacing the Battery Pack .....	29
Recharging the Battery Pack .....	30
Replacing Alkaline (LR20) Dry Cell Batteries .....	30
Filter Replacement .....	32

---

<b>CALIBRATION .....</b>	<b>35</b>
Calibration Validity .....	35

---

<b>ACCESSORIES.....</b>	<b>37</b>
-------------------------	-----------

---

<b>ADDITIONAL INFORMATION .....</b>	<b>41</b>
Training .....	41
World Wide Web .....	41

---

<b>TYPICAL OPERATING PARAMETERS .....</b>	<b>A-1</b>
Size .....	A-2
Weight .....	A-2
Operating Temperature .....	A-2
Humidity .....	A-2
Construction .....	A-2
Display .....	A-2
Sampling System .....	A-2
Power Source .....	A-2

---

<b>FIELD CALIBRATION .....</b>	<b>B-1</b>
Selectable Ranges in FCM .....	B-3
Entering FCM .....	B-3
Zeroing the Instrument .....	B-4
Field Calibration Procedure .....	B-5
Quitting FCM .....	B-9
Quit And Save Changes .....	B-9
Quit Without Saving Changes .....	B-9

---

<b>OPERATING INSTRUCTIONS .....</b>	<b>C-1</b>
-------------------------------------	------------

---

<b>INDEX .....</b>	<b>I</b>
--------------------	----------

## INTRODUCTION

The Oxygas P-500 is a two button instrument designed to measure Parts Per Million, Lower Explosive Level, Volume flammable gas and Oxygen for (CGI) leak detection and purge operations. The instrument is designed to the latest standards and is certified for use in Hazardous Areas.



The Oxygas P-500 contains the following ranges:

- LEL, 0 to 100%
- Volume gas, 0 to 100%
- PPM Flammable, 0 to 1000ppm
- Oxygen, 0 to 25%

## Overview

This chapter provides a brief overview of the principles of operation of the instrument in its two modes of operation.

- 1) Combustible Gas Indicator - Leak Detection
- 2) Purging

This is not intended as operating instruction in the application of finding leaks, monitoring atmospheres or practical purging operations. In all cases, you should follow your company and application specific training.

### Combustible Gas Indicator - Leak Detection

When there is a fire or explosion, there are usually three contributors, as indicated in the following diagram, i.e. Fuel, Oxygen or Air, and an Ignition Source.

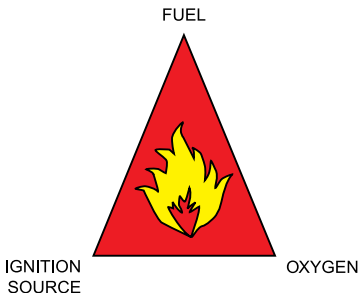

**Figure 1.2** Contributors to Fire / Explosion

In some applications, all three sources are available, e.g. a boiler burner.

In other applications, where gas may be liable to escape or be present, ignition sources are controlled, e.g. hazardous or zoned areas.

In applications, such as purging, the Air or Oxygen source is controlled or excluded.

In normal operation, where air is not excluded apart from displacement by the fuel itself, fuel and air can mix causing potentially explosive mixtures.

If insufficient fuel is present, e.g. the mixture is too "lean" to cause ignition, then the atmosphere is "safe".

The minimum amount of fuel in air that can cause an explosion is called the Lower Explosive or Flammable Limit - LEL / LFL. If the mixture has too much fuel, and hence insufficient air, then again combustion cannot occur. The maximum fuel in air ratio, where combustion can occur, is called the Upper Explosive or Flammable Limit - UEL / UFL.

These figures assume normal atmospheres - gas in air -21% Oxygen in 79% Nitrogen. If either the O<sub>2</sub> or the N<sub>2</sub> ratio varies significantly, then different conditions apply to the flammable limits and the instrument application.

The normal measurement for gas in air atmospheres is % LEL.

This measurement is not used in inert atmospheres where the % Gas or % Oxygen measurement must be used.

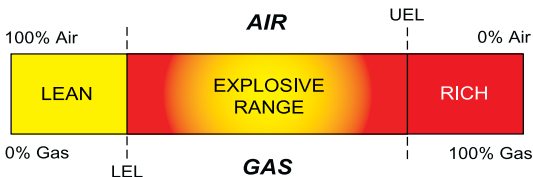

**Figure 1.3** Flammability

The Oxygas P-500 uses a catalytic sensor to measure LEL, which requires air to be present, and a thermal conductivity sensor to measure the % Volume range.

## Purging

The opening of a pipeline or vessel causes a mixing of flammable products, such as gas with air, creating potentially flammable mixtures.

It may not be possible to ensure that all sources of ignition are removed, hence there is a need to avoid the formation of flammable mixtures.

Two types of purging are generally used:

- Direct Purging - Displacement of fuel by air, or vice versa.
- Indirect Purging - Displacement of fuel by inert gas followed by displacement by air, or vice versa.

Indirect purging is the most common since it avoids flammable mixtures being created.

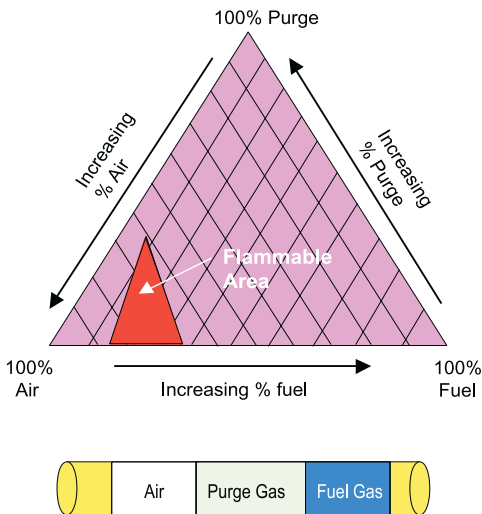
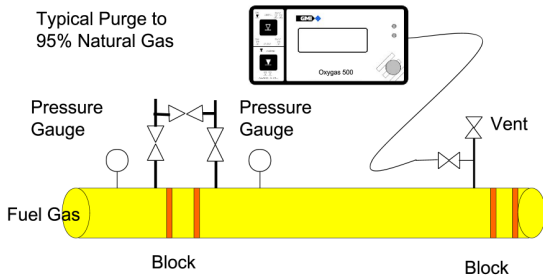

**Figure 1.4** Principle of Purging

When the pipe has been open to atmosphere for maintenance or when first being put into service, there is a requirement to introduce flammable gas into the pipe in a controlled way to avoid large flammable mixtures being created and to avoid air being introduced into the network.

This is done by avoiding air and fuel mixing by introducing an inert or purge gas into the system so that air and fuel don't meet. This gas is normally Nitrogen or a mixture of Nitrogen and Carbon Dioxide.

The following diagram illustrates a typical direct purging operation and is not intended to demonstrate the purge technique, but illustrate the effect on the instrument reading.



**Figure 1.5** Direct Purging - Commissioning

### Commissioning

In the direct purge mode for commissioning, the pipe would contain air and the pipe would be purged with Natural Gas. The Oxygen is zeroed in air and would be switched on in the purge mode. In commissioning the pipe would typically be purged to 95% Natural Gas. This would be a normal operation, however, in instruments calibrated in Methane you may only be able to attain 85-90% reading, depending upon the composition of the gas and the accuracy of calibration. The Natural Gas may only contain 90% or less of Methane, hence the calibration gas and the measured gas should be as close together as possible in composition for purging or an allowance made for the difference.



## De-commissioning

In purging down to air the typical figure would be 2% Methane or around 40% LEL to end the purge.

In the Purge mode only the % Gas and the O<sub>2</sub> ranges are available and normally the % Vol range can be used. A reading can be taken from the O<sub>2</sub> range for confirmation but care should be taken that the pressure applied to the cell is the same or similar to the zero point, ie atmospheric pressure. The pipe is being pressurised from atmospheric hence by inference the pressure will change. The O<sub>2</sub> cell can be pressure transient sensitive, so care should be taken to ensure that the pressure is maintained the same by means of suitable valves or flow orifices and time allowed for the transient effect to be minimised before a reading is taken.

## Direct Purging

Although it is normal to use the Purge mode of the Oxygas for purging, in direct purging where there is no inert atmosphere in the pipe the instrument will operate in the Measure mode.

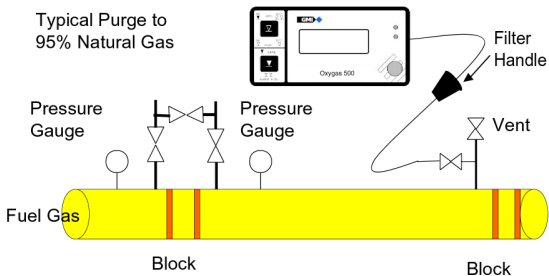

**Figure 1.6** Direct Purging - De-commissioning

When commissioning, the instrument will start in the LEL range and autorange up automatically to % Gas when the LEL reaches around 110% or the %Gas is greater than about 5.5%. Thus above these values of gas in air the instrument will be in the %Gas range and the reading increase up to the final purge reading of >95% gas (85 - 95% depending on calibration).

In direct purging to air the instrument in the measure mode will start off in % Gas and reduce the reading in the gas range until it autoranges back to LEL at around 4.5% CH<sub>4</sub> in air or 99% LEL.

In the measure mode the LEL and % Vol ranges have autotracking which forces the LEL and % Gas signals to be the same.

In the Purge mode the instrument will only have % O<sub>2</sub> and % Gas ranges and autotracking is disabled.

With 2% CH<sub>4</sub> or 40% LEL the Oxygen content of the sample is only reduced by around 0.4% O<sub>2</sub> which may be difficult to measure accurately.

**THE MEASURE MODE SHOULD NOT BE USED FOR INDIRECT PURGING.**

## Indirect Purging

The following diagram shows a typical indirect purging operation using a Nitrogen cylinder.

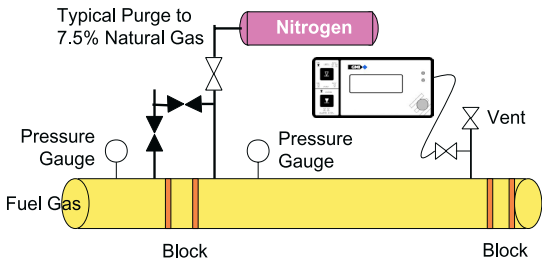

**Figure 1.7** Indirect Purging - De-commissioning

In this situation Nitrogen or an inert gas is used to purge the vessel of flammable gas; the above illustration does not fully describe purging, only its influence on the instrument.

For indirect operations, the instrument must be used in the purge mode.

In decommissioning the pipe, the end point is the % of Gas left in the pipe when it has mainly been displaced by Nitrogen. A typical figure for this would be 7.5 - 8%CH<sub>4</sub> to give a mixture that when mixed with air would not form an explosive mixture. Since there is no air in the pipe, Oxygen measurement cannot be used apart from as a safety check.

Nitrogen has a different thermal conductivity to air and hence the reading for 100% Nitrogen is different than for 100% Air (20% O<sub>2</sub> / 80% N<sub>2</sub>).

Since 100% air is used to set zero at switch-on, it is the zero that is affected by the difference between air and Nitrogen.

There is a typical difference in reading between these two conditions of around 5% on the % Volume scale when calibrated in Methane on an Oxygas.

100% Nitrogen gives a negative reading of around -5% when compared with an air zero and obviously the 20% O<sub>2</sub> reading drops to 0% in 100% N<sub>2</sub>.

To enable the influence of the Nitrogen to be seen and compensated for in this condition, when the Oxygas is placed in the PURGE mode negative readings are enabled on the %Gas scale. The instrument will read approximately -5% when in a 100% N<sub>2</sub> atmosphere and the results will be influenced by the % of N<sub>2</sub> in the sample as the reading is reduced.

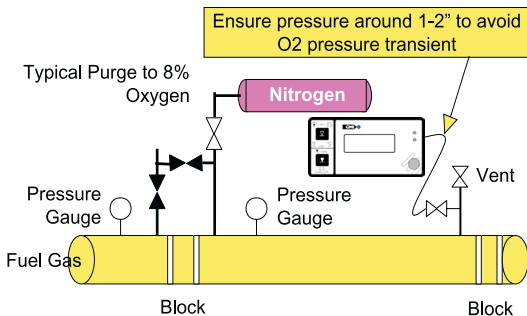

**Figure 1.8** Indirect Purging - Commissioning (Air to Inert)

At an actual 5% CH<sub>4</sub> in Nitrogen the influence of the Nitrogen on the % Gas reading is around 95% of -5% gas = - 4.75%, hence the actual meter reading will be around +0.25%.

At 7.5% CH<sub>4</sub> the reading will be influenced by the zero shifting by 92.5% of -5 = +3%.

At an actual reading of 7.5% the mixture will be higher in concentration by around 2.5 - 3% gas.

These numbers still fall within the 30% safety factor normally used.

As the Oxygas P-500 has a wide variety of available user selected options, it is not possible to provide an operator handbook specific to each possible variation, therefore, what we have provided in the following pages is the standard default of how the instrument would generally be configured, with the possible options detailed in *italic* text.

GMI recommend that you take the time to study your instrument and, where practical and with advice from your company's Purchasing / Management departments, highlight your particular instrument configuration.

The main features of the instrument are:

- Rugged carbon loaded polypropylene case, sealed to IP54 rating and suitable for outdoor use.
- Two button operation allowing the user access to all features.
- LCD with backlighting which displays the current gas readings (in both digital and analogue forms) together with operational and status information.
- Directly interfaces with the GMI Auto Test Calibration Units.



## GENERAL INFORMATION

### Ranges of Operation

#### LEL, 0 to 100%

The LEL range indicates the explosivity of the flammable gas in the sample. This is displayed as a percentage of the lower explosive limit (LEL) of the gas. For methane 100% LEL corresponds to 5% Volume methane in Air.

The instrument range is displayed in the top right corner of the display as % LEL. From 0 to 10% LEL the digital display resolves to 0.1% LEL. From 10 to 100% LEL the digital display resolves to 1% LEL. The analogue bar graph follows in 4% steps. An example of the LEL display is shown in Figure 2.1. Autoranging will automatically switch the range to Volume Gas when 100% LEL is reached.

The detection principle for this range is a catalytic reaction.

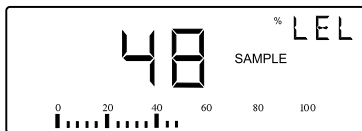
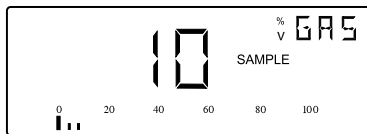

Figure 2.1 LEL Range

## Volume Gas, 0 to 100 %

This range displays the total volume of a specific flammable gas with respect to air. The calibration gas is shown on the service label and for the purpose of this handbook is assumed to be methane. Instruments calibrated for methane in air should only be used for measuring such mixtures. To change the calibration gas, e.g. from methane to propane, the instrument must be recalibrated by suitably trained personnel.

On the Volume Gas range the instrument range is displayed in the top right corner of the LCD as GAS. The digital display resolves the signal to 1% GAS with the analogue bar graph following in steps of 4%. Figure 2.2 shows the Volume Gas display. The detection principle for the Volume Gas range is thermal conductivity.



**Figure 2.2** Volume Gas Range

## Oxygen, 0 – 25%

This range displays the percentage Oxygen content of the sample. The instrument range is displayed in the top right corner of the display as % O<sub>2</sub>. From 0 to 21% O<sub>2</sub> the digital display resolves to 0.1% O<sub>2</sub>. From 21 to 25% O<sub>2</sub> the digital display resolves to 1% O<sub>2</sub>. The analogue bar graph follows in 4% steps.

The gas level is determined using an electrochemical cell, which like toxic sensors is sensitive to pressure transients. The oxygen cell has an expected life of two years.



## **PPM Flammable 0 – 1000 ppm**

This range is used to measure very low levels of gas and indicates the parts per million concentration of the gas in air (1000 ppm is equivalent to 0.1% Volume Gas).

The digital display reading resolves to 5 ppm with the analogue bargraph following in steps of 40 ppm. The ppm range is more sensitive than LEL and Volume ranges and takes longer to stabilise. The detection principle is a catalytic reaction with the sensitivity of the sensors greatly enhanced compared to the LEL range. Digital signal correction techniques are used to minimise drift. The ppm range includes a manual zeroing procedure.

.....

## **Construction**

The instrument is housed in a tough, impact resistant, moulded case made of carbon loaded polypropylene.

The top panel is protected by a stainless steel top plate covering a toughened glass LCD cover.

The battery pack is sealed and attached to the main instrument body by means of 2 stainless steel hexagonal screws.

The instrument is sealed against dust and water to IP54 standard. The sensors are protected from dust and water by membrane and cotton filters.

## Batteries

### Disposable Alkaline (LR20) Dry Cell Batteries

Alkaline batteries provide approximately 15 hours operational life at ambient temperature of 20°C (68°F). When the batteries are low or exhausted it is necessary to fit 4 new batteries. Do not mix old and new batteries.

An indication of the battery condition is displayed after power on and during warm-up, with status shown as either OK or LO. If LO condition is displayed, a maximum battery operational life of 120 minutes remains. During operation the 'BAT' alarm flag is displayed when approximately 60 minutes of operating time remains at normal temperature. The instrument may continue to be used until it switches off automatically.

### Rechargeable Battery Pack

The GMI rechargeable battery pack provides approximately nine hours operational life, from fully charged, at ambient temperature of 20°C (68°F). An indication of the battery condition is displayed after power on and during warm-up, with status shown as either OK or LO. If LO condition is displayed, a maximum battery operational life of 90 minutes remains. During operation the 'BAT' flag is displayed when approximately 30 minutes operating time is left at normal temperatures. The instrument will then turn off.

There are three GMI Battery Chargers: a Standard Charger, a Flatbed Charger and a Smart Charger. The Smart Charger has both slow and fast charge options as well as a serial link for communications with the instrument. See Rechargeable Battery Pack in Section 4 OPERATOR MAINTENANCE.

## Filters

A number of different filter types are available from GMI. The minimum requirement is a cotton particulate filter and a hydrophobic filter which are incorporated in the probe handle assembly supplied with the instrument. Filters must be checked at frequent intervals and where appropriate changed to ensure a clean sample path. If water is drawn into the instrument any filter which has been contaminated must be cleaned or replaced. See Filter Replacement in Section 4 OPERATOR MAINTENANCE.

## Liquid Crystal Display (LCD)

The LCD shows the current gas readings in both analogue and digital form together with operational and status information. The display is protected by a toughened glass cover. Backlighting is provided to enable the display to be seen under low ambient light conditions.

## Before Use Checks

The following checks should be carried out before using the instrument on site:

- The instrument is clean and in good condition.
- The batteries have sufficient power left in them for the intended use of the instrument.
- The filters are clean and in good condition.
- The sample line and any accessories are in good condition and leak free.
- All gas ranges are operational and zeroed correctly.
- The calibration is still valid.



## OPERATING INSTRUCTIONS

### Modes of Operation

The instrument has two modes of operation which are accessed by switching the instrument ON with either Button One or Button Two.

One  or Button Two . See Figure 3.1 below.

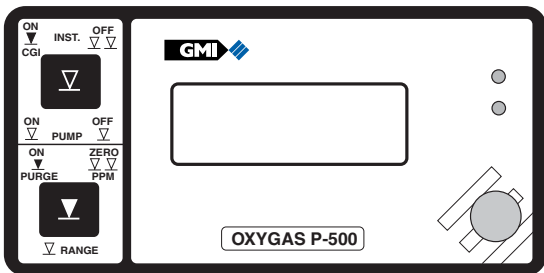



Figure 3.1 Instrument Front Plate

**Mode 1 (CGI):** Switching ON with Button One  provides four gas ranges

- LEL autoranging to Volume Gas, and
- Oxygen Range 0-25%.
- PPM range (0 - 1000ppm).

**Mode 2 (Purge):** Switching ON with Button Two  provides access to only 0-100% Vol Gas and 0-25% Oxygen for purge applications.

## Switching On

Press and hold Button One  to turn the instrument on. This initiates the instruments warm up cycle and switches on the pump. Figure 3.2 displays the warm up cycle for the Oxygas P-500.

All LCD segments displayed

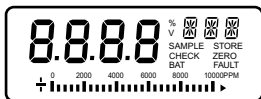

Instrument type      Software version

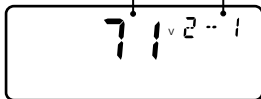

Battery status

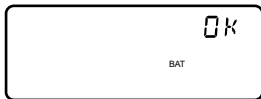

Note: Battery status is displayed as either OK or LO at start-up.

**Figure 3.2** Warm Up

## Calibration Date Features

At the end of warm-up and before the Oxygas P-500 instrument is ready for measuring, the instrument will indicate on the display when the next calibration is due. This will be displayed as month and year, as shown in Figure 3.3:



**Figure 3.3** Calibration Date

The re-calibration interval pre-set for all Oxygas P-500 instruments is twelve (12) months.

*This period can be altered as an option, however, you should ensure that the instrument is always within its calibration period prior to use.*

*An option which ensures that an 'out of calibration instrument' is not used, is the automatic switch-off when overdue.*

## Switching Off the Instrument Pump

A single press of Button One , when the pump is running, turns the pump off and stops sampling. Pressing button one again turns the pump back on.

## Switching On in Purge Mode

To switch on in Purge mode, press and hold Button Two .

The Oxygas P-500 will initiate the warm-up sequence as explained previously. This mode uses the Volume Gas and Oxygen ranges only. When in purge mode, the PURGE flag is activated on the display, as shown in Figure 3.4.



**Figure 3.4** Purge Mode

## Changing Range

Each single press of Button Two  changes the gas range selected. The display cycles through the available ranges as follows:

LEL/Vol.Gas – Oxygen – PPM – LEL/Vol.Gas (in CGI mode)

Volume Gas – Oxygen – Volume Gas (in Purge mode)

**Note:** The instrument, by default, auto-ranges between LEL and Volume Gas.



## Zeroing the PPM Range

A double press of Button Two  zeroes the current range. This should be carried out in fresh air and may take a few minutes to reach the optimum zero stability. The display in Figure 3.5 occurs if a large adjustment is needed to reach the zero point.

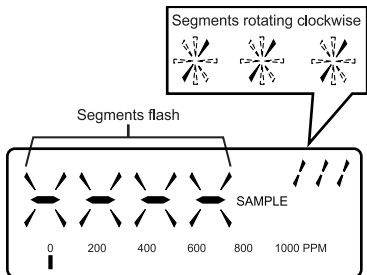

Figure 3.5 Zeroing Range

## Switching Off



A double press of Button One  turns the instrument off immediately.

The instrument switches off automatically after 30 minutes. 'OFF' is shown in the top right hand corner of the display. Pressing any button cancels this automatic switch-off. The instrument will then allow another 30 minutes of use.

*This 30 minute period is set as a default.*

*The switch off time may be altered to any time between 1 and 1000 minutes*

## Summary of Button Operation

Mode	Single Press	Double Press	Press and Hold
<b>Button 1</b> 	Toggles Pump ON / OFF (during operation)	Switches Instrument OFF	Switches Instrument ON (CGI)
<b>Button 2</b> 	Next Range LEL/VOL - O <sub>2</sub> - PPM (CGI) VOL - O <sub>2</sub> - VOL (Purge)	Zero PPM	Switches Instrument ON (Purge)

## Operator Messages / Fault Flags

Various messages can appear on the LCD screen to indicate instrument status.

### ‘SAMPLE’

This indicates that the pump is running and the instrument is sampling.

### ‘OFF’

This indicates that the instrument is about to switch off. This command can be cancelled by a single press of any button.

### ‘SAMPLE FAULT’

This indicates a problem with the instrument’s flow due to the sample path being blocked, water ingress, a blocked filter or pump failure.

In Measure mode, the pump stops automatically. The sample line, filters etc. should be checked for water ingress or

blockage and Button One  should then be pressed to restart the pump.

### **‘CHECK ZERO’**

This indicates that there may have been a zero shift due to the presence of gas. Switch off the instrument and switch on again in fresh air.

### **‘ZERO FAULT’**

This indicates that the zero is outwith its calibration limits. Switch the instrument off and then on again in fresh air. If the fault does not clear, return the instrument for servicing.

### **‘BAT’**

This indicates that the batteries will soon require replacement. At this point there will be approximately 60 minutes operation left in a set of alkaline batteries, although this figure will vary depending on battery manufacturer, temperature conditions, usage etc. With rechargeable batteries the ‘BAT’ flag indicates approximately 30 minutes operation left.

As the battery power continues to fall, the LCD flashes a ‘BAT FAULT’ message. Subsequently the LCD displays ‘OFF’ and the instrument automatically switches off. The batteries should be replaced immediately.

### **‘BAT FAULT’**

This indicates that the batteries require replacing.

### **‘1’**

This message which can also appear after power on, indicates that a calibration data error has been detected. The instrument should be returned for servicing.



---

## OPERATOR MAINTENANCE

### Rechargeable Battery Pack

Three battery chargers are available from GMI, a Standard Charger, a Flatbed Charger and a Smart Charger.

#### Standard Charger



The GMI Standard Charger takes approximately 14 hours to charge a flat battery.

Note: The 4-button instrument is for illustration purposes only.

## Flatbed Charger



The GMI Flatbed Charger allows the Gasurveyor's battery pack to be charged in NORMAL mode, which takes approximately 14 hours to charge a flat battery. The Mode Select Switch can then be set to STAND-BY, where a trickle charge will maintain the battery in a fully charged state of readiness.

Note: The 4-button instrument is for illustration purposes only.

## Smart Charger



The GMI Smart Charger provides both fast and standard charging facilities and can charge an instrument and spare

battery pack simultaneously. Using the standard charging option, a battery pack can be recharged in 12 hours from a fully discharged state. Using the fast charge option a battery pack can be 90% recharged in approximately 60 minutes and fully recharged in 120 minutes. To ensure optimum life length, the rechargeable pack should be fully discharged and charged on a regular basis of, at least, every three months. The Smart Charger has the option of switching to discharge and fast charge cycle to provide this facility.

Note: The 4-button instrument is for illustration purposes only.

## Replacing the Battery Pack

The following procedure should be carried out in a safe area:

- 1) Loosen the two instrument base screws (4mm hex) using the special tool provided.



- 2) Remove the battery pack.
- 3) Insert new battery pack.
- 4) Fasten base screws.

- 5) Check that instrument switches on and works to specification.

## **Recharging the Battery Pack**

The battery pack should be recharged in the following situations:

The BAT or BAT FAULT message is displayed.

The instrument will not switch on.

The pump will not switch on.

It is recommended that the battery pack is fully discharged on a regular basis (once every three months). This can be done by running the instrument continuously or using the battery conditioning facility on the Smart Charger. The batteries can be charged on the instrument but the instrument itself should be switched off. Regular complete discharge will keep the battery pack in good condition.

## **Replacing Alkaline (LR20) Dry Cell Batteries**

All four batteries should be replaced at any one time and in a safe area. GMI only recommend the use of Energiser or Duracell cells.

- 1) Loosen the two instrument base screws (4mm hex) using the special tool provided.





- 2) Remove battery cover.
- 3) Remove the old batteries.
- 4) Check battery compartment for damage to spring contacts or corrosion on springs.

---

**Caution: Under no circumstances should rechargeable batteries be fitted in place of Alkaline batteries.**

---

- 5) Insert four new batteries observing correct polarity indication in battery compartment base.
- 6) Replace battery cover and fasten base screws.
- 7) Check that the instrument switches on and works to specification.

## Filter Replacement

Hydrophobic and cotton particulate filters in the probe handle minimise the danger of water and dust ingress.

---

**Caution: The instrument should never be switched on without suitable filters installed.**

---

If a blockage occurs the 'SAMPLE FAULT' indicator is displayed. Check the sample line and probe handle for blockage. Press Button One  to clear the 'SAMPLE FAULT' message. Replace the filter(s) if the message does not clear.

To replace the filter(s), proceed as follows:

- 1) Unscrew the probe handle assembly.

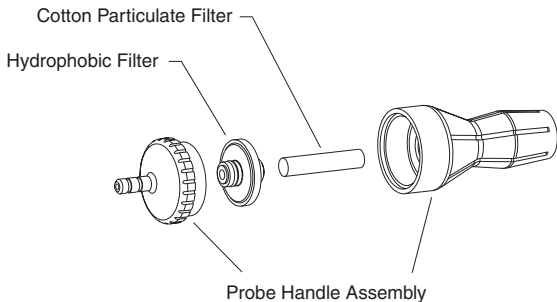

**Figure 4.1** Filter Assembly

- 2) Remove the cotton particulate filter and discard.
- 3) Remove the hydrophobic filter.
- 4) Clean the probe handle to make sure that it is free from dirt and water.
- 5) Fit a new cotton particulate filter.
- 6) Fit the hydrophobic filter. The yellow label on the filter fits against the yellow label on the probe handle.
- 7) Reassemble the probe handle assembly.



## **CALIBRATION**

The instrument has been calibrated for a particular flammable gas mixture. Where any doubt exists the instrument should be returned to GMI or an authorised distributor for calibration.

### **Calibration Validity**

Calibration validity is the responsibility of the user. Under normal operating conditions a 12 month period can be expected. This is no guarantee, however, as the precise application of the product is unknown to GMI. Individual codes of practice may dictate shorter periods.

Regular checking establishes a pattern of reliability and enables the calibration check period to be modified in line with operational experience. The higher the risk, the more frequently calibration should be checked. ie the probe handle assembly.



---

## ACCESSORIES

### Accessories Supplied with Oxygas P-500 Instrument

Part Number **42501P / 42501PR**

<b>Part Number</b>	<b>Description</b>
42119	Carrying Case
12370/2	Shoulder Harness
12451	4mm Hex. Driver
12712	Clear Sample Line x 1.5 metres. (4ft.10ins.) approx.
12480	Plastic Probe - Solid End 35cm. (1ft.2ins.) approx.
12481	Probe Handle c/w Filters
10077	Cotton Particulate Filters (Box of 10) x 2
12688	Sample Line Adaptor
42645	User Handbook

### Additional Accessories Available

<b>Part Number</b>	<b>Description</b>
13184	Standard Charger / 240V Power Supply (UK PLug)
13317	Standard Charger / 220V Power Supply (Euro Plug)
13322	Standard Charger / 110V Power Supply (USA Plug)

12888	Standard Charger / 220V Power Supply (Australian Plug)
13179	Standard Charger w/o Power Supply
42121	Flatbed Charger / 240V Power Supply (UK PLug)
42122	Flatbed Charger / 220V Power Supply (Euro Plug)
42123	Flatbed Charger / 110V Power Supply (USA Plug)
12889	Flatbed Charger / 220V Power Supply (Australian Plug)
42124	Flatbed Charger w/o Power Supply
13180	240V Power Supply (UK Plug)
13320	220V Power Supply (Euro Plug)
13321	110V Power Supply (USA Plug)
12241	220V Power Supply (Australian Plug)
13100	Smart Charger with Datalogging Software c/w 240V Power Supply (UK Plug)
13440	Smart Charger with Datalogging Software c/w 220V Power Supply (Euro Plug)
13340	Smart Charger with Datalogging Software c/w 110V Power Supply (USA Plug)
12890	Smart Charger with Datalogging Software c/w 220V Power Supply (Australian Plug)
42114	Spare Rechargeable Battery Pack
13703	Manual Calibration for Windows (Software)
12552	Communications Link Adaptor
12358	Hydrophobic Filter (use with 12481)
12229	Stainless Steel Probe - Closed End 80cm. (2ft.6ins.) approx.
12393	Plastic Probe - Solid End 80cm. (2ft.6ins.) approx.



- 12394 Flexible Probe - Open End  
35cm. (1ft.2ins.) approx.
- 13427 Plastic Probe - Open End  
35cm. (1ft.2ins.) approx.
- 13413 Stainless Steel Probe - Open End  
35cm. (1ft.2ins.) approx.
- 12895 Barbed Probe - Solid End  
69cm. (2ft.3ins.) approx.
- 12894 Barbed Probe - Open End  
69cm. (2ft.3ins.) approx.
- 13561 Probe Handle
- 13562 Probe Handle Adaptor  
(use with 13563 or 13565)
- 13563 Bellows Cup Probe
- 13565 Swan Neck Probe
- 13655 Probe Shroud c/w Skids (use with 13565)
- 12365 In-Line Hydrophobic Filter Holder
- 42141 Gasurveyor 500 Standard Accessory  
Pack.  
Consisting of: Gasurveyor 500 Carrying  
Case ; Standard Probe ; Probe Handle  
Assembly ; Sample Line Adaptor ;  
2 Packs Cotton Filters.
- 42151 Gasurveyor 500 Gas Industry Survey  
Accessory Pack.  
Consisting of: Gas Industry Survey  
Carrying Case (Large) ; Probe Handle  
Assembly ; Probe Handle Adaptor ;  
Bellows Probe.  
Note: Large carrying case has space  
for special probes, e.g. Swan  
Neck

Note: For other sampling probes and accessories, and for calibration gases, contact GMI Ltd.



## **ADDITIONAL INFORMATION**

### **Training**

Training courses are available on all our products. Contact our Marketing Department for further details:

Tel: +44 (0) 141 812 3211

Fax: +44 (0) 141 812 7820

e-mail: [sales@gmiuk.com](mailto:sales@gmiuk.com)

### **World Wide Web**

Visit our web site at [www.gmiuk.com](http://www.gmiuk.com)



---

## TYPICAL OPERATING PARAMETERS

Typical operating parameters are as follows:

Gas Range	Range	Resolution	Zero Stability	Accuracy
LEL	0 to 10%	0.1%	+/- 0.5%	
	10 to 100%	1%	N/A	2% +/- 1% LEL
Volume Gas	0 to 100%	1%	+/- 2%	1% +/- 1% Gas
Oxygen	0 to 21%	0.1%	+/- 0.5%	+/- 0.5% + 3% reading
	21 to 25%	1%	N/A	+/- 0.5% + 3% reading

### Notes:

All the values above are at normal temperature and pressure.

Humidity is between 0% and 95% RH (non-condensing).

Pressure changes at the inlet and exhaust are minimised as they may cause transient changes in reading.

## Size

180mm (7.08") x 95mm (3.74") x 105mm (4.13")

## Weight

1.7kg (3.75lbs.) with alkaline batteries

## Operating Temperature

-20 °C to 50 °C (-4 °F to 122 °F)

## Humidity

0 – 95% RH

## Construction

Moulded polypropylene case protected to IP54

## Display

LCD containing:

Analogue display scaled 0-10, 0-100, 0-1000 or 0-10000

4 digit digital display

3 character range indication

Operational flags

## Sampling System

Integral pump with flow fail sensor.

The sample path is protected by the hydrophobic filter and automatic pump switch off.

## Power Source

4 'D' size alkaline cells giving approximately 15 hours runtime at 20 °C (68 °F)..

Rechargeable (NiCd) battery pack giving approximately 9 hours runtime at 20 °C (68 °F).

## **FIELD CALIBRATION**

Field calibration allows simple calibration to be carried out in the field without the use of additional test equipment. Other calibration procedures require the use of the GMI Manual Calibration software or the Workshop System.

There are fundamentals, in terms of instrument calibration, that should be noted:

- The gas should be of known traceable quality and have total analysis.
- The gas should be applied in the same manner as the instrument is used, e.g. at a known pressure which is constant and around, or slightly above, normal atmospheric pressure.
- The use of demand type regulators is not recommended on instruments with Oxygen or Toxic cells since these are affected by pressure pulses.

In Field Calibration Mode (FCM) the buttons perform the functions indicated in CAL Mode or SPAN Mode as shown in Figure B-1.

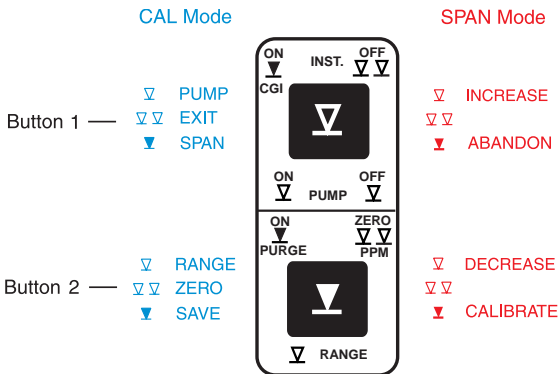

**Figure B-1** Button Functions

To simplify button operation when calibrating the instrument, an overlay card, shown in Figure B-2, is available and can be placed over the top face of the instrument to identify calibration button functions. Contact GMI for details.

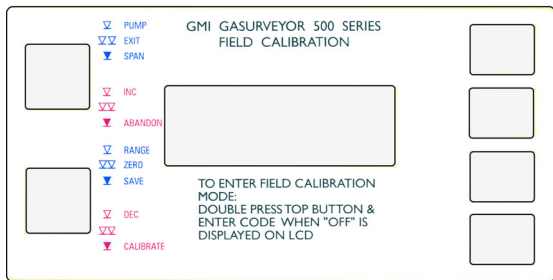

**Figure B-2** Instrument Overlay Card



## Selectable Ranges in FCM

When in FCM the following ranges are manually selectable by pressing Button Two : LEL, Volume GAS, Oxygen.

## Entering FCM

- 1) Switch the instrument on and allow it to complete its warm-up checks.
- 2) Double press Button One  to initiate instrument switch off. While OFF is displayed in the LCD and before the instrument actually switches off, enter the access code.

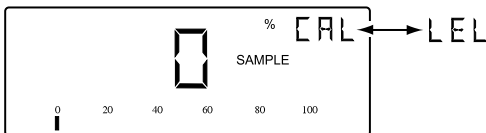

**Note:** Allow at least one second between button presses when entering the button sequence. The default (factory set) entry code is button sequence 1,2,1,2. Alternative codes are user selectable.

When the instrument is in FCM, the “CAL” message alternates on the display with the currently selected range. An example of the display is shown in Figure B-3.





**Figure B-3** Field Calibration Display

In CAL mode, the instrument buttons have the functions shown in Figure B-4.

CAL Mode	Single Press	Double Press	Press and Hold
<b>Button 1</b> 	Toggle Pump On / Off	Exit CAL Mode	Enter SPAN Mode
<b>Button 2</b> 	Next Range	Zero Current Range	Save CAL Data

**Figure B-4** CAL Mode Button Functions

## Zeroing the Instrument

- 1) Enter FCM. See the previous section ENTERING FCM.
- 2) Double press Button Two  to zero current gas range.
- 3) Single press Button Two  to select the next gas range.
- 4) Repeat steps 2 and 3 until all gas ranges have been zeroed.
- 5) Proceed to FIELD CALIBRATION PROCEDURE to calibrate the instrument.

## Field Calibration Procedure

- 1) Zero gas ranges before attempting calibration. See previous section ZEROING THE INSTRUMENT for details.
- 2) Make sure that the instrument pump is running and the gas range selected is compatible with the calibration gas.

Note: A single press of Button One  toggles the pump Off / On.

- 3) Remove the cap from calibration gas cylinder. Make sure that the regulator valve is in the fully closed position (Off) then connect the gas regulator to the gas cylinder (push down gently and tighten clockwise, hand tight). See Figure B-5 for details.

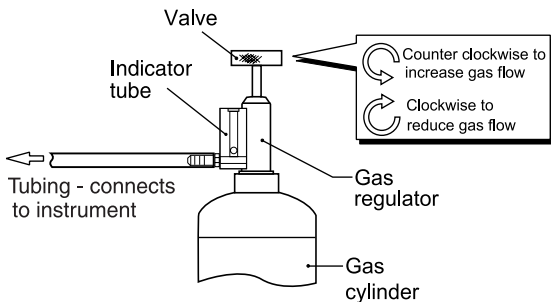

**Figure B-5** Connecting Gas

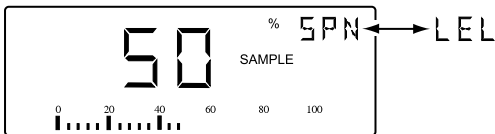

- 4) Turn the regulator valve counter clockwise to open the valve slightly. Make sure that the gas is flowing before connecting the sample tubing to the instrument, otherwise an instrument sample fault may occur.
- 5) Connect tubing from regulator to instrument inlet then adjust the regulator valve to maintain a constant flow of gas (counter clockwise to increase flow and clockwise to decrease).. The correct flow rate is achieved when the ball in the indicator tube floats just above its resting position.
- 6) Wait for the instrument gas reading to settle.
- 7) If the displayed reading corresponds to the concentration of calibration gas, i.e. 50% LEL (2.5% Methane in Air), proceed to paragraph 10.
- 8) If the displayed reading does not correspond to the concentration of calibration gas, i.e. 50% LEL (2.5% Methane in Air), press and hold Button One  to enter SPAN mode.

SPAN mode is indicated by the selected range, in this case LEL, and SPN alternating in the display as shown in Figure B-6.





**Figure B-6** SPAN Mode Display

In SPAN mode, the instrument buttons have the functions shown in Figure B-7.

SPAN Mode	Single Press	Double Press	Press and Hold
<b>Button 1</b> 	Increase Set Point	–	Exit SPAN Without CAL
<b>Button 2</b> 	Decrease Set Point	–	Exit SPAN With CAL

**Figure B-7** SPAN Mode Button Functions

8a) In SPAN mode, a single press of Button One  will produce small incremental changes to increase display reading, or a single press of Button Two  will produce small decremental changes to decrease display reading, until the displayed gas value corresponds to the concentration of the calibration gas.

8b) When required reading has been reached, press and hold Button Two  to exit SPAN mode with calibration. The display may jump above and below required reading momentarily as the instrument performs the calibration.

Note: If for any reason you require to exit SPAN mode without calibration of the instrument, press and hold Button One .

- 9) The calibrated instrument display will now return to CAL mode display as shown in Figure B-8.

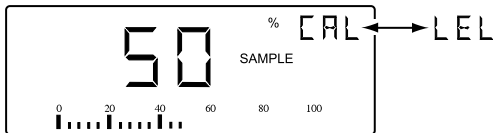



**Figure B-8** 50% LEL Display

- 10) Make sure that correct reading is displayed before disconnecting the calibration gas then disconnect tubing from instrument inlet and turn regulator valve on calibration gas cylinder in a clockwise direction to turn off gas flow.
- 11) Make sure that the regulator valve is in the fully closed position (Off) then disconnect the regulator from the gas cylinder (turn regulator body in a counter clockwise direction).
- 12) Replace the cap on the calibration gas cylinder.
- 13) Repeat steps 1 to 12 for each range to be calibrated otherwise quit FCM. See QUITTING FCM for further details.

## Quitting FCM

### Quit And Save Changes

- 1) Press and hold Button Two  to save CAL data.
- 2) Double press Button One  to exit FCM.

Note: When all ranges have been zeroed, calibrated correctly, CAL data saved and followed by CAL mode exit, the new CAL DUE date will be set to 12 months from now. (This can be altered to a different frequency, via the set-up program, e.g. 6 months from now. Contact GMI for details).

### Quit Without Saving Changes

- 1) Double press Button One  to exit FCM.

Note: When you exit the FCM without saving the new CAL data, the old calibration data and calibration date remains in the instrument memory.





---

## OPERATING INSTRUCTIONS

The following instructions provide the user with a quick guide to the operation of the . . .



 **Oxygas P-500** instrument.

## CHECKLIST

1. Check the instrument has no obvious faults.
2. Check accessories.
3. Read and understand handbook before use.
4. Switch ON
5. Check battery levels.
6. Check "ZERO" in fresh air.

## SAFETY

- The instrument must be regularly serviced and calibrated by fully trained personnel in a safe area.
- **Batteries:** Alkaline batteries or \*Rechargeable battery pack must be exchanged (\*and recharged) in a safe area and fitted correctly before use. Never use damaged batteries or expose to extreme heat.
- Only GMI replacement parts should be used.
- If the instrument detects gas, follow your own organisation's procedures and operational guidelines.
- The combustion chamber is a flameproof assembly and must not be opened in the presence of a flammable atmosphere.
- Oxygas P-500 instruments are certified as EEx iad IIC T4 (-20°C ≤ Tamb ≤ 50°C).

BAS01ATEX2292   II 2 G.



UL Class 1 Groups A, B, C and D.

- This equipment is designed and manufactured to protect against other hazards as defined in paragraph 1.2.7 of Annex II of the ATEX Directive 94/9/EC

Any right of claim relating to product liability or consequential damage to any third party against GMI is removed if the warnings are not observed.

## AREAS OF USE

Exposure to certain chemicals can result in a loss of sensitivity of the flammable sensor. Where such environments are known or suspected it is recommended that more frequent response checks are carried out. The chemical compounds that can cause loss of sensitivity include Silicones, Lead, Halogens and Sulphur. Do not use instrument in potentially hazardous atmospheres containing greater than 21% Oxygen.

## Oxygas P-500 - Operating Instructions

The enclosure material is polypropylene and must not be exposed to environments which are liable to result in mechanical or thermal degradation or to damage caused by contact with aggressive substances. Additional protection may be required in environments where the instrument enclosure is liable to damage.

### OPERATOR MESSAGES / FAULT FLAGS

Various messages can appear on the LCD screen to indicate instrument status.

**'SAMPLE'** Indication that the pump is running and the instrument is sampling.

**'OFF'** Indication that the instrument is about to switch off. This command can be cancelled by a single press of any button.

**'SAMPLE FAULT'** Indication of a problem with the instrument's flow due to the sample path being blocked, water ingress, a blocked filter or pump failure. In Measure mode, the pump stops automatically.

The sample line, filters etc. should be checked for water ingress or blockage and Button One should then be pressed to restart the pump.

**'CHECK ZERO'** Indication that there may have been a zero shift due to the presence of gas. Switch off the instrument and switch on again in fresh air.

**'ZERO FAULT'** Indication that the zero is outwith its calibration limits. Switch the instrument off and then on again in fresh air. If the fault does not clear, return the instrument for servicing.

**'BAT'** Indication that the batteries will soon require replacement. At this point there will be approximately 60 minutes left in a set of alkaline batteries, although this figure will vary depending on battery manufacturer, temperature conditions, usage etc.

With rechargeable batteries the 'BAT' flag indicates approximately 30 minutes operation left.

As the battery power continues to fall, the LCD flashes a 'BAT FAULT' message. Subsequently the LCD displays 'OFF' and the instrument automatically switches off.

The batteries should be replaced immediately.

**'BAT FAULT'** Indication that the batteries should be replaced immediately.

**'1'** Indication, which can also appear after power on, that a calibration data error has been detected. The instrument should be returned for servicing.

## OPERATION

BUTTON 1

BUTTON 2

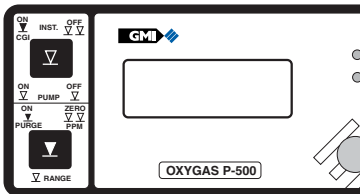

### Switch ON (CGI Mode)

LEL autoranging to Volume Gas ; Oxygen ; PPM.

Press and Hold Button One  to switch instrument and pump On. This initiates the instrument's warm-up cycle.

### Switch ON (Purge Mode)

0 to 100% Volume Gas ; Oxygen, for purge applications.

Press and Hold Button Two

 to switch instrument and pump On. This initiates the instrument's warm-up cycle.

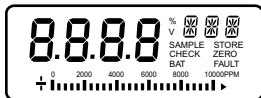

All LCD segments are displayed

All LCD segments display is followed by Instrument Type and Software version,

Instrument type      Software version

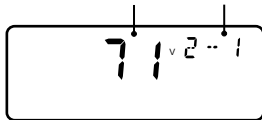

then Battery status, as shown:



Next, the instrument indicates, as month and year, when the next calibration is due. (February 2005 in example)

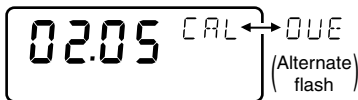

The CAL DUE display screen is followed by the current gas detection reading.

Note: When in Purge mode, the PURGE flag is activated on the display, as shown:

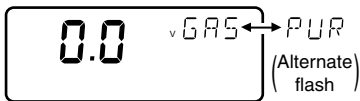

### Pump ON / OFF

A single press of Button One  when the

pump is running turns the pump off and stops sampling. A further press of Button One turns the pump back on.

### Changing Range

Each single press of Button Two  changes the gas range.

The display cycles through the available ranges in the order: LEL/Vol.Gas – Oxygen – PPM – LEL/Vol.Gas, etc. (CGI Mode)  
Vol. Gas – Oxygen – Vol. Gas, etc. (Purge Mode).

### Zeroing the PPM Range

A double press of Button Two  zeroes the PPM range. This should be carried out in fresh air and may take a few minutes to reach the optimum zero stability.

### Switch OFF

A double press of Button One  turns the instrument Off.



# Index

## Symbols

1 25

## A

ACCESSORIES 37

Accuracy A-1

ADVICE, DISPOSAL i

alkaline A-2

Alkaline (LR20) Dry Cell

Batteries 16, 30

AREAS OF USE ii

## B

BAT 25

BAT FAULT 25

Batteries 16

Battery Pack

16, 27, 29, 30

Before Use Checks 17

Button Operation 24

## C

CALIBRATION 35, B-1

Calibration Date Features

21

Calibration Procedure B-5

Calibration Validity 35

CGI 19

Changing Range 22

Charger, Flatbed 28

Charger, Smart 28

Charger, Standard 27

CHECK ZERO 25

Combustible Gas Indicator -  
Leak Detection 2

Commissioning 6

Construction 15, A-2

COPYRIGHT i

## D

De-commissioning 7

Direct Purging 7

Display A-2

Disposable Alkaline (LR20)

Dry Cell Batteries 16

DISPOSAL ADVICE i

## E

Entering FCM B-3

## F

FAULT, BAT 25  
Fault Flags 24  
FAULT, SAMPLE 24  
FAULT, ZERO 25  
FCM B-1, B-3, B-9  
features 11  
FIELD CALIBRATION B-1  
Field Calibration Procedure  
B-5  
Filter Replacement 32  
Filters 17  
Flatbed Charger 28

## G

GENERAL INFORMATION  
13

## H

HANDLING ii  
Humidity A-2

## I

Indirect Purging 9  
INFORMATION, ADDI-  
TIONAL 41  
INSTRUCTIONS, OPER-  
ATING C-1  
INTRODUCTION 1  
Issue 1 2

## L

LCD 17, A-2  
LEL 13  
LIABILITY i  
Liquid Crystal Display 17

## M

MAINTENANCE 27  
Manual Datalogging 24  
Modes of Operation 19  
MODIFICATION NOTICES  
i

## N

NiCd A-2  
NOTICES, MODIFICATION  
i

## O

OFF 24  
OPERATING INSTRUC-  
TIONS 19, C-1  
OPERATING PARAM-  
ETERS A-1  
Operating Temperature A-  
2  
OPERATOR MAINTEN-  
ANCE 27  
Operator Messages 24  
Overview 2  
Oxygen 14



## **P**

PARAMETERS, OPERATING A-1

Power Source A-2

PPM Flammable 15

Purge 20

Purge Mode 22

Purging 4

Purging, Direct 7

Purging, Indirect 9

## **Q**

Quit And Save Changes B-9

Quit Without Saving  
Changes B-9

Quitting FCM B-9

## **R**

Range 22

ranges 1

Ranges of Operation 13

Rechargeable Battery Pack  
16, 27

Recharging the Battery  
Pack 30

Replacement, Filter 32

Replacing Alkaline (LR20)  
Dry Cell Batteries 30

Replacing the Battery Pack  
29

Resolution A-1

REVISION RECORD iii

## **S**

SAFETY ii

SAMPLE 24

SAMPLE FAULT 24, 32

Sampling System A-2

Save Changes B-9

Selectable Ranges in FCM  
B-2

Size A-2

Smart Charger 28

SOFTWARE i

Standard Charger 27

STORAGE ii

Summary of Button  
Operation 24

Switching Off 23

Switching Off the Instru-  
ment Pump 21

Switching On 20

Switching On in Purge  
Mode 22

## **T**

Training 41

TRANSIT ii

## **V**

Validity, Calibration 35

Volume Gas 14

## **W**

Weight A-2

World Wide Web 41

## **Z**

Zero A-1

ZERO, CHECK 25

ZERO FAULT 25

Zeroing the Instrument B-4

Zeroing the PPM Range 23



**GMI Head Office:**

Inchinnan Business Park,  
Renfrew,  
PA4 9RG,  
Scotland, U.K.  
Telephone +44 (0)141 812 3211  
Fax +44 (0)141 812 7820  
e-mail: [sales@gmiuk.com](mailto:sales@gmiuk.com)  
<http://www.gmiuk.com>

**GMI Instrument Service / Repair Centre:**

Crownhill, 25 Cochran Close,  
Milton Keynes,  
MK8 OAJ,  
England, U.K.  
Telephone +44 (0)1908 568867  
Fax +44 (0)1908 261056  
e-mail: [service@gmiuk.com](mailto:service@gmiuk.com)

