

davitrac

Davit arm for confined space entry, safe lifting solution.

davitrac

Davit arm for confined space entry, retrieval and fall protection

The davitrac is a complete solution for safe vertical rope access or material lifting in a confined space situation. **Mobile and efficient solution for rescue situations.**

It offers protection and total mobility for two people simultaneously, during work involving a risk of falling. Its compatibility with the Tractel® product range allows a large number of possible configurations.

QUALITY:

- Compact.
- Easy to use.
- Compatible for suspended work.
- Rope access: Manual or motorized.
- Lifting material: Manual or motorized.

ERGONOMICS:

- Easy handling / Very lightweight: less than 30kg.
- Integrated carrying handle.
- Easy to transport.
- Easy to install: installation by 1 person in less than two minutes without tools.



Foldable - easy to handle and to transport

TECHNICAL CHARACTERISTICS:

- Weight: 29,7 kg (without accessories & bases).
- 2 users: 150kg each.
- Maximum load capacity (materials): WLL 500 kg.

COMPATIBLE APPLICATIONS

- Rescue
- Confined spaces
- Rope works
- Manholes
- Pits
- Sewerod access
- Pipes
- Oil and gas
- Civil engineering
- Industry
- Wind and solar installation

FLEXIBILITY:

- Can be semi-permanent or permanent.
- Well suited for use as a transportable anchor point for working in confined spaces.
- Anchorage for 2 users.
- Can be used for lifting materials.
- Different type of bases.
- Modular: different combinations possible with lifting and fall arrest device Tractel® products.

SECURITY:

- Equipped with 150 kg PPE anchor points: secures 2 people simultaneously (one worker in the confined space and one worker operating the davitrac).

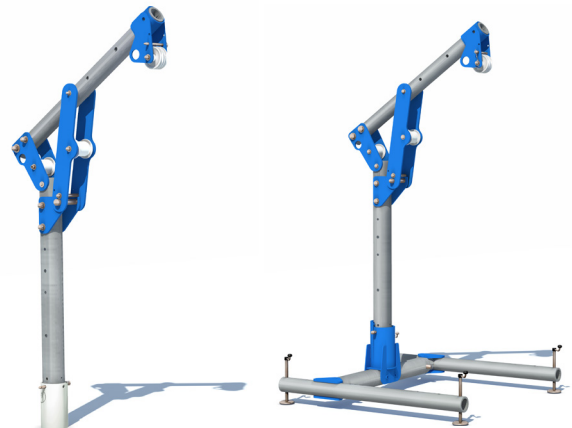

Standards

davitrac complies with:

- **EN 795-A: 2012** (fixed anchor points)
- **EN 795-B: 2012** (transportable anchors) - when using with portable H self-stabilizing adapter
- **CEN/TS 16415: 2013-B** (Fall arrest for 2 users of 150 kg each)
- **Machine Directive 2006/42/CE** (Material lifting)

Can be used with system conform to:

- EN 360, EN 353.2 or EN 355 (Individual protection of operators against falls)
- EN 1496 (rescue)
- EN 341 (descender devices)
- Rope access directive 2001/45/CE
- Machine Directive 2006/42/CE (Material lifting)

Tractel® supports you in your project and offers you a wide range of individual and collective protection solution that secures the operations.

Contact us for more information: www.tractel.com

Several solutions with Tractel® product range



Scan this QR Code & find the solution suitable for your needs

<https://www.tractel.com/global/products/confined-space>

WLL 500kg max

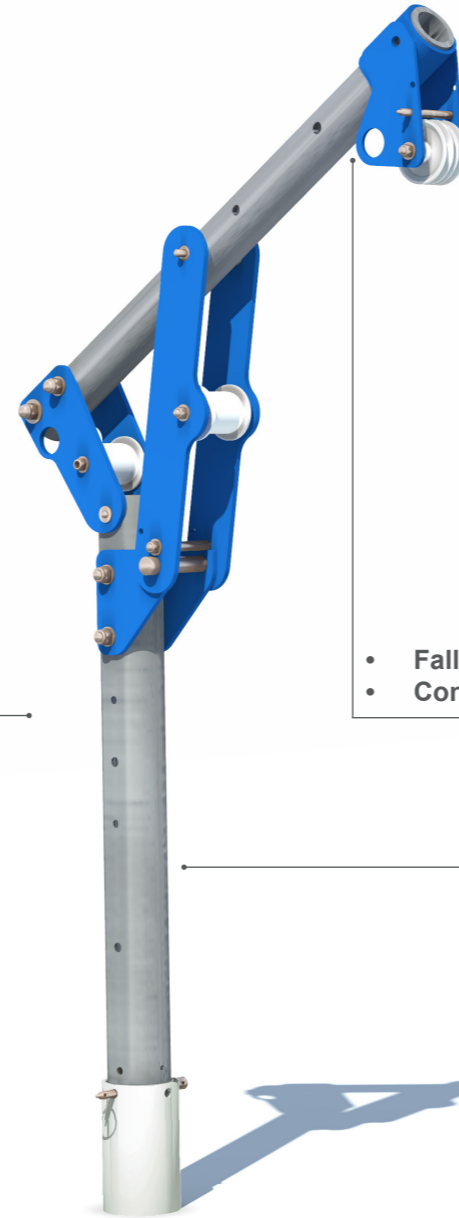

- ++
For lifting material & rescue people
- Manual winches (caRol™)
 - Motorised winches (caRol™)
 - Hand-operated wire rope hoist with stirrup adapter (scafor™)



- Fall arresters on a flexible anchor line (stopfor™)
- Controlled speed descent evacuation system (derope™)



- ++
Permits to handle material, without height limitation
- Traction hoists (tirak™)
 - Lifting hoists (minifor™)
 - Manual chain hoists (tralift™)

- Automatic fall arresters with integrated winch (blocfor™ R)

++
Perfectly suitable for rescue people

Range of adapter options offers complete versatility

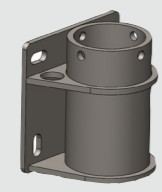

Wall mounted adapter
Wall mounted adapter fixed to concrete or steel vertical structures. Adapter with anchoring points to secure two persons (150kg each) at the same time.

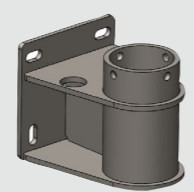

Clearance mural adapter
Clearance mural adapter (with 291mm offset) fixed to concrete or steel vertical structures. Adapter with anchoring points to secure two persons (150kg each) at the same time.

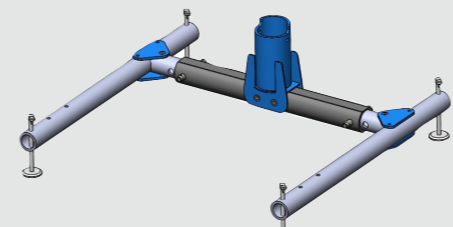

Portable H self-stabilizing adapter
Portable H self stabilizing base to be used when a fixed base can't be installed definitely. Perfect transportable solution for fall protection as well as material lifting. Its adjustable base allows it to be used for any type of standard confined access.

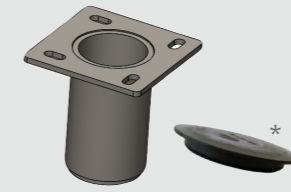

Flush floor adapter
Flush adapter moulded into the concrete. Ideal to have no obstacles on the ground surface to prevent falls.
*Delivered with a special protection stopper, to use when davitrac is not used/integrated on the adapter.

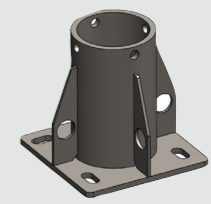

Mounted floor adapter
Mounted floor adapter fixed to concrete or steel horizontal structure. Adapter with anchoring points to secure two persons (150kg each) at the same time.

davitrac

Davit arm for confined space entry, retrieval and fall protection

A Arm

- Rod made of aluminium.
- Lightweight materials.

B Bases

- Different types of bases: fixed and mobile bases.

C Anchorages

- EN 795 anchor points for fall arresters.
- Certified for fall arrest for 2 users (150kg each) at the same time.
- Also certified for lifting material (tirak™, minifor™, tralift™ ...).

D 2 guided cable pulley

- As an automatic fall protection device with integrated winch for ascending or descending during a possible rescue operation or/and rescue winch.

E F Option: bracket for blocfor™ 20R or 30R*

- Plate for integration of an automatic fall protection device with integrated winch for ascending or descending during a possible rescue operation.

F E Option: bracket for caRol™ or scafor*

- Plate for integration of a rescue winch.

G 360° rotating mast (with locking every 90°)

- Facilitates handling for material lifting and the recovery of persons.

H Quick release

- To fold the davitrac (facilitates transport).

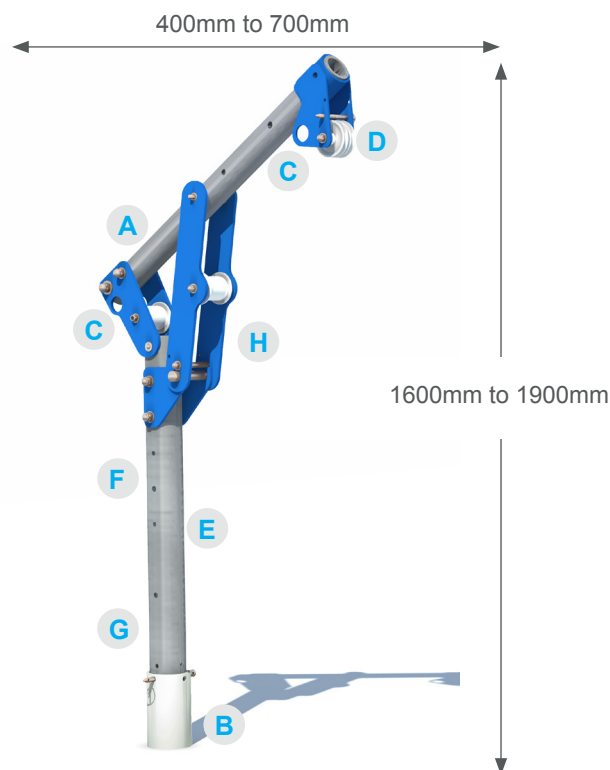

* Both brackets can be integrated at the front or rear of the mast.

Accessories



Trolley for davitrac



Transport bag

| Model name | Product code |
|----------------------------------|--------------|
| davitrac | 286819 |
| Wall mounted adapter | 210118 |
| Clearance mural adapter | 210128 |
| Mounted floor adapter | 210108 |
| Flush floor adapter | 210138 |
| Portable H base self-stabilizing | 210098 |
| Trolley for davitrac | 210618 |
| Transport bag | 84582 |

GLOBAL REACH

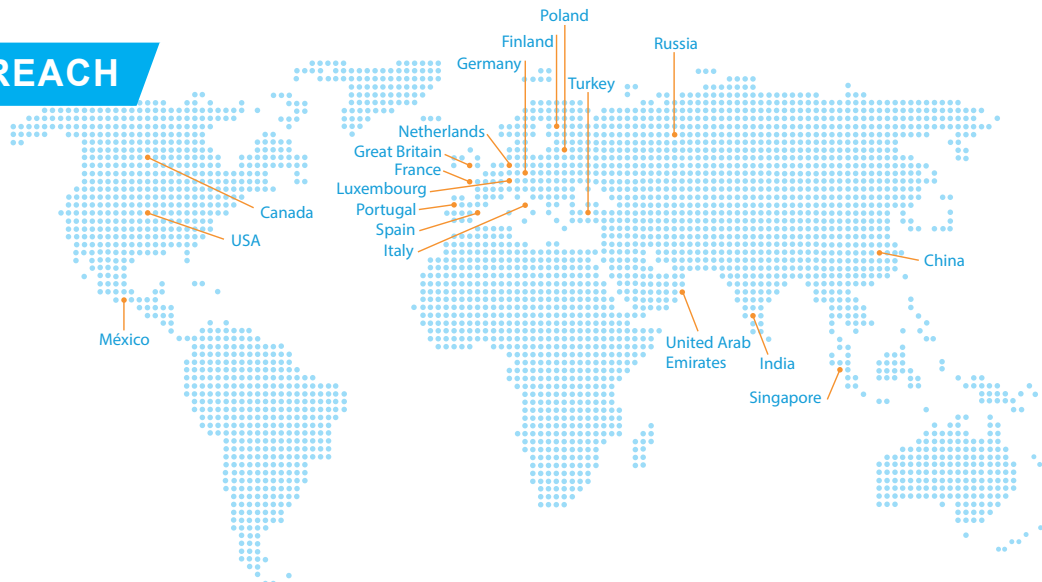

NORTH AMERICA

CANADA

Tractel Ltd.
1615 Warden Avenue
Toronto, Ontario M1R 2T3, Canada
Phone: +1 800 465 4738
Fax: +1 416 298 0168
Email: marketing.swingstage@tractel.com

11020 Mirabeau Street
Montréal, QC H1J 2S3, Canada
Phone: +1 800 561 3229
Fax: +1 514 493 3342
Email: tractel.canada@tractel.com

MÉXICO

Tractel México S.A. de C.V.
Galileo #20, O cina 504.
Colonia Polanco
México, D.F. CP. 11560
Phone: +52 55 6721 8719
Fax: +52 55 6721 8718
Email: tractel.mexico@tractel.com

USA

Tractel Inc.
51 Morgan Drive
Norwood, MA 02062, USA
Phone: +1 800 421 0246
Fax: +1 781 826 3642
Email: tractel.usa-east@tractel.com

168 Mason Way
Unit B2
City of Industry, CA 91746, USA
Phone: +1 800 675 6727
Fax: +1 626 937 6730
Email: tractel.usa-west@tractel.com

BlueWater L.L.C

4064 Peavey Road
Chaska, MN 55318, USA
Phone: +1 866 579 3965
Email: info@bluewater-mfg.com

Fabenco, Inc

2002 Karbach St.
Houston, Texas 77092, USA
Phone: +1 713 686 6620
Fax: +1 713 688 8031
Email: info@safetygate.com

EUROPE

GERMANY

Tractel Greifzug GmbH
Scheidtbachstrasse 19-21
51469 Bergisch Gladbach, Germany
Phone: +49 22 02 10 04-0
Fax: +49 22 02 10 04 70
Email: info.greifzug@tractel.com

LUXEMBOURG

Tractel Secalt S.A.
Rue de l'Industrie 12
B.P 1113 - 3895 Foetz, Luxembourg
Phone: +352 43 42 42-1
Fax: +352 43 42 42-200
Email: secalt@tractel.com

SPAIN

Tractel Ibérica S.A.
Carretera del Medio, 265
08907 L'Hospitalet del Llobregat
Barcelona, Spain
Phone: +34 93 335 11 00
Fax: +34 93 336 39 16
Email: infotib@tractel.com

FRANCE

Tractel S.A.S.
RD 619 Saint-Hilaire-sous-Romilly
BP 38 Romilly-sur-Seine
10102, France
Phone: +33 3 25 21 07 00
Email: info.tsas@tractel.com

Ile de France Maintenance Service S.A.S.

Zac du Gué de Launay
77360 Vaires sur Marne, France
Phone: +33 1 56 29 22 22
E-mail: ifms.tractel@tractel.com

Tractel Location Service

Zac du Gué de Launay
77360 Vaires sur Marne, France
Phone: +33 1 60 36 30 00
E-mail: info.tls@tractel.com

Tractel Solutions S.A.S.

77-79, rue Jules Guesde
69230 St Genis-Laval, France
Phone: +33 4 78 50 18 18
Fax: +33 4 72 66 25 41
Email: info.tractelsolutions@tractel.com

GREAT BRITAIN

Tractel UK Limited
Old Lane Halfway
Sheffield S20 3GA, United Kingdom
Phone: +44 114 248 22 66
Email: sales.uk@tractel.com

ITALY

Tractel Italiana SpA
Viale Europa 50
Cologno Monzese (Milano) 20093, Italy
Phone: +39 02 254 47 86
Fax: +39 02 254 71 39
Email: infoit@tractel.com

NETHERLANDS

Tractel Benelux BV
Paardeweide 38
Breda 4824 EH, Netherlands
Phone: +31 76 54 35 135
Fax: +31 76 54 35 136
Email: sales.benelux@tractel.com

PORTUGAL

Lusotractel Lda
Bairro Alto Do Outeiro Armazém 1
Trajouce, 2785-653 S. Domingos
de Rana, Portugal
Phone: +351 214 459 800
Fax: +351 214 459809
Email: comercial.lusotractel@tractel.com

POLAND

Tractel Polska Sp. z o.o.
ul. Bylawska 82
Warszawa 04-993, Poland
Phone: +48 22 616 42 44
Fax: +48 22 616 42 47
Email: tractel.polska@tractel.com

NORDICS

Tractel Nordics (Scanclimber OY)
Turkkirata 26
FI - 33960
Pirkalla, Finland
Phone: +358 10 680 7000
Fax: +358 10 680 7033
E-mail: tractel@scanclimber.com

RUSSIA

Tractel Russia O.O.O.
Olympiysky Prospect 38, Office 411
Mytishchi, Moscow Region
141006, Russia
Phone: +7 495 989 5135
Email: info.russia@tractel.com

ASIA

CHINA

Shanghai Tractel Mechanical Equip. Tech. Co. Ltd.
2nd oor, Block 1, 3500 Xiupu road,
Kangqiao, Pudong,
Shanghai, People's Republic of China
Phone: +86 21 6322 5570
Fax: +86 21 5353 0982

SINGAPORE

Tractel Singapore Pte Ltd
50 Woodlands Industrial Park E7
Singapore 757824
Phone: +65 6757 3113
Fax: +65 6757 3003
Email: enquiry@tractelsingapore.com

UAE

Tractel Secalt SA Dubai Branch
Office 1404, Prime Tower Business Bay
PB 25768 Dubai, United Arab Emirates
Phone: +971 4 343 0703
Email: tractel.me@tractel.com

INDIA

Secalt India Pvt Ltd.
412/A, 4th Floor, C-Wing, Kailash
Business Park, Veer Savarkar Road,
Parksite, Vikhroli West,
Mumbai 400079, India
Phone: +91 22 25175470/71/72
Email: info@secalt-india.com

TURKEY

Knot Yapı ve İş Güvenliği San.Tic. A.Ş.
Cevizli Mh. Tugay Yolu CD.
Nuvo Dragos Sitesi
A/120 Kat.11 Maltepe
34846 Istanbul, Turkey
Phone: +90 216 377 13 13
Fax: +90 216 377 54 44
Email: info@knot.com.tr

ANY OTHER COUNTRIES:

Tractel S.A.S.

RD 619 Saint-Hilaire-sous-Romilly
BP 38 Romilly-sur-Seine
10102, France
Phone: +33 3 25 21 07 00
Email: info.tsas@tractel.com



www.tractel.com

